



 1 X K02	 4 X W04	 6 X S01
 28 X W01	 16 X W02	 18 X W03
 2 X ^{L+P} L01	 2 X L02	





2

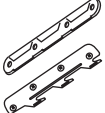
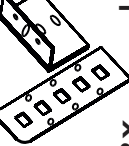
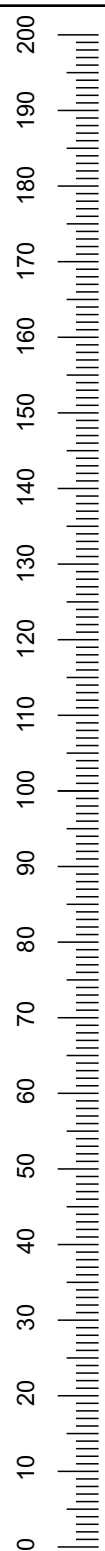
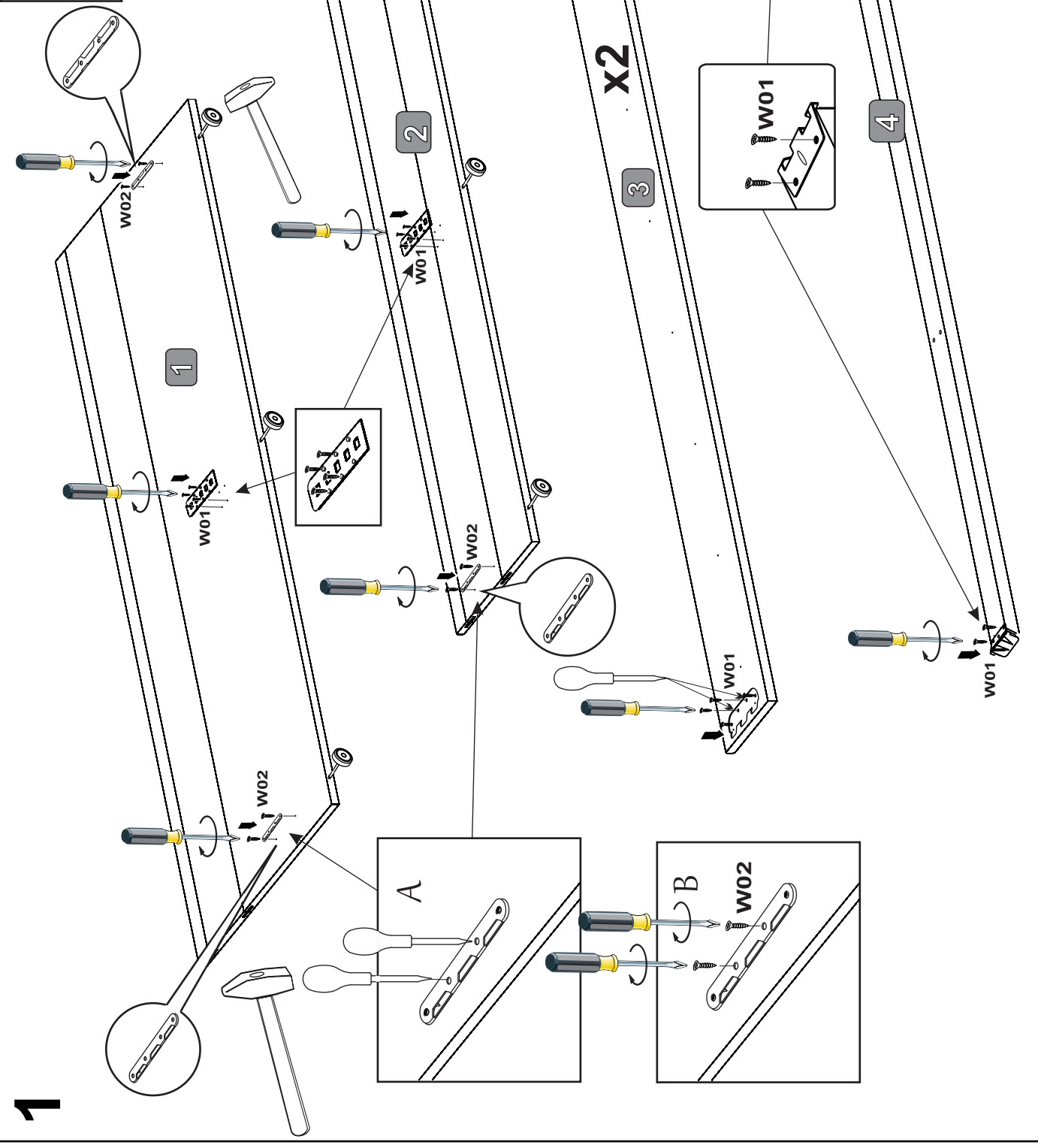
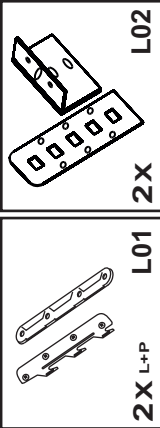
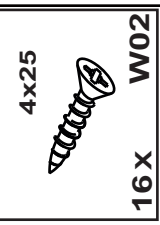
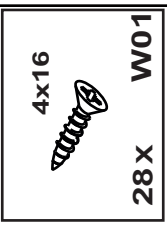
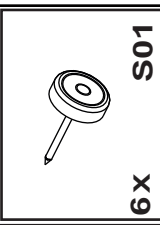
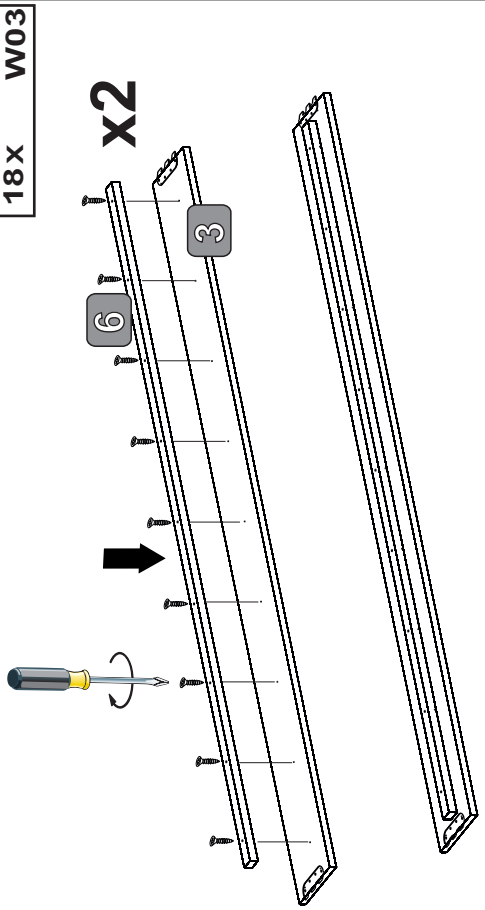

3

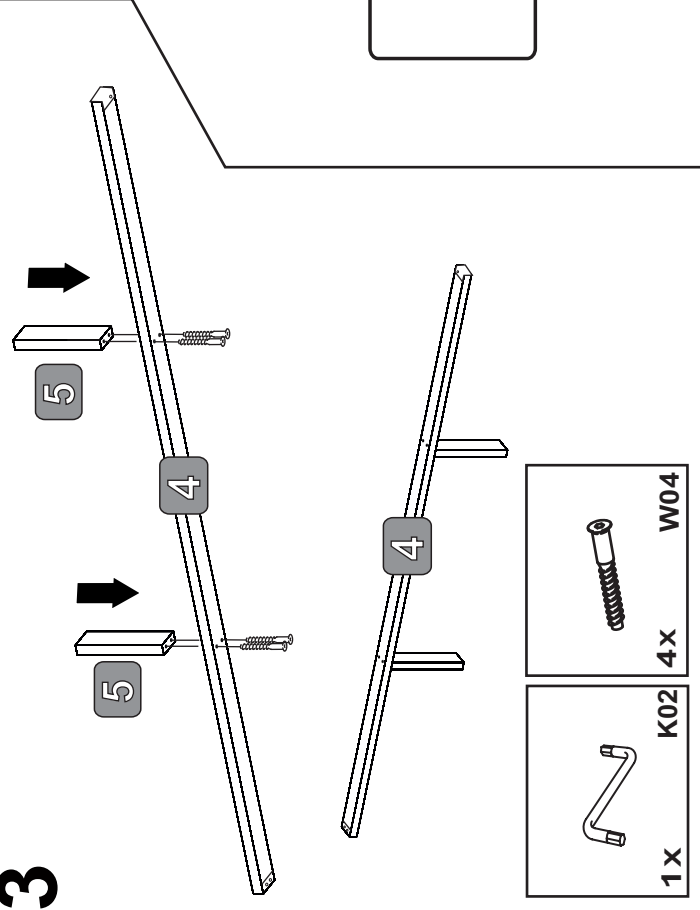

4

