

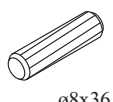







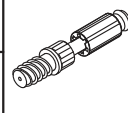

160 min.

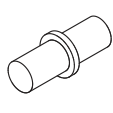
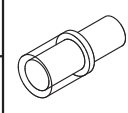
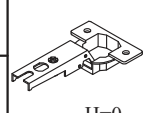
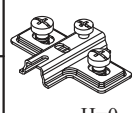
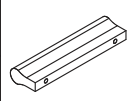
A1 X12  ø8x36	B11 X8  Ø7x50	G4 X8 	B4 X6 	B5 X6  ø15x12	G5 X6 
G7 X8 	G20 X2 	E1 X4  H=0	E2 X4  H=0	KL X4 	UP6 X8  UPØ4x30
Z2 X4  Ø5	KR1 X1 	L1 X1 	S1 X10 	I11 X4 	H5 X1 
D10 X14  USØ3,5x13	D11 X4  USØ3,5x25	D8 X4  ESØ5x13	B3 X5  Ø1,4x25	G2 X1 	G8 X1  901mm

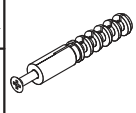
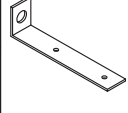
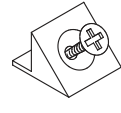
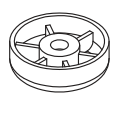
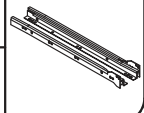

1

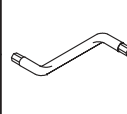
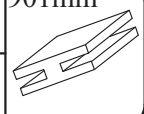
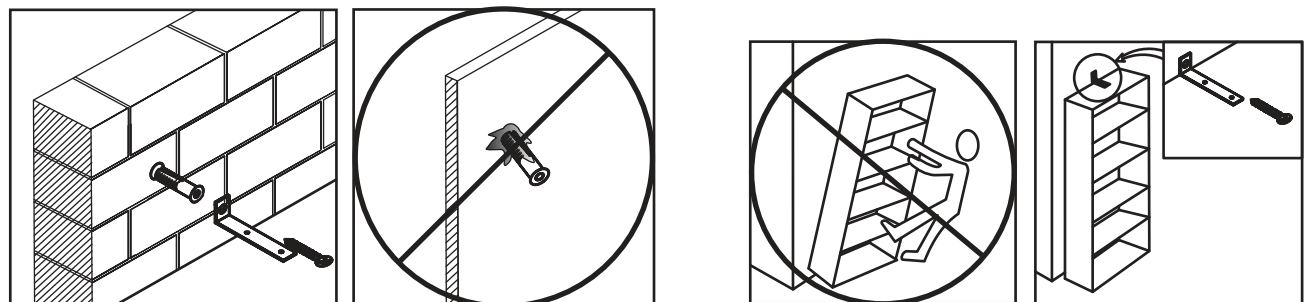
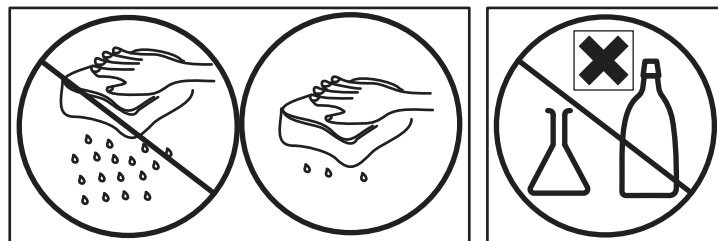
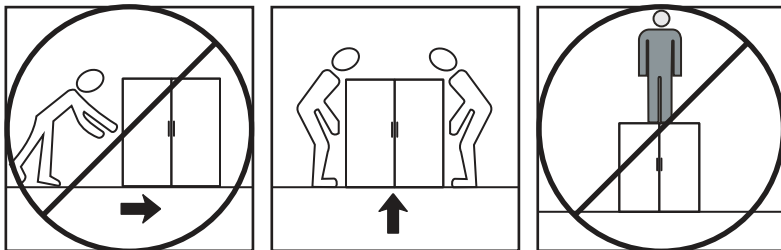
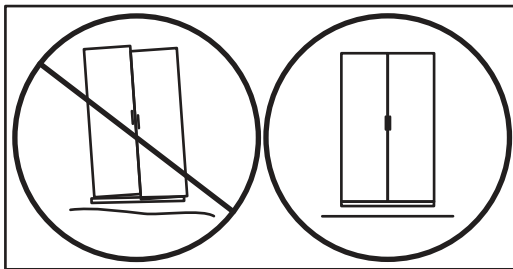
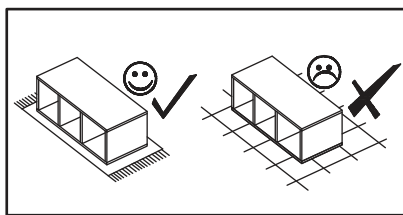
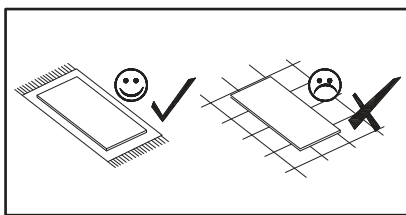
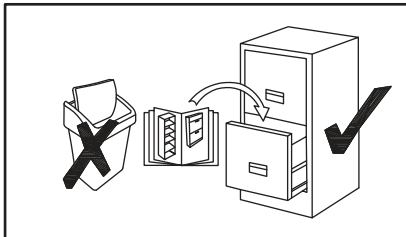
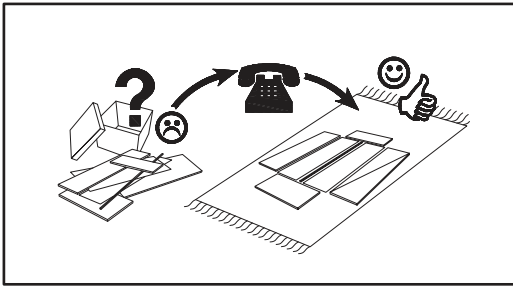
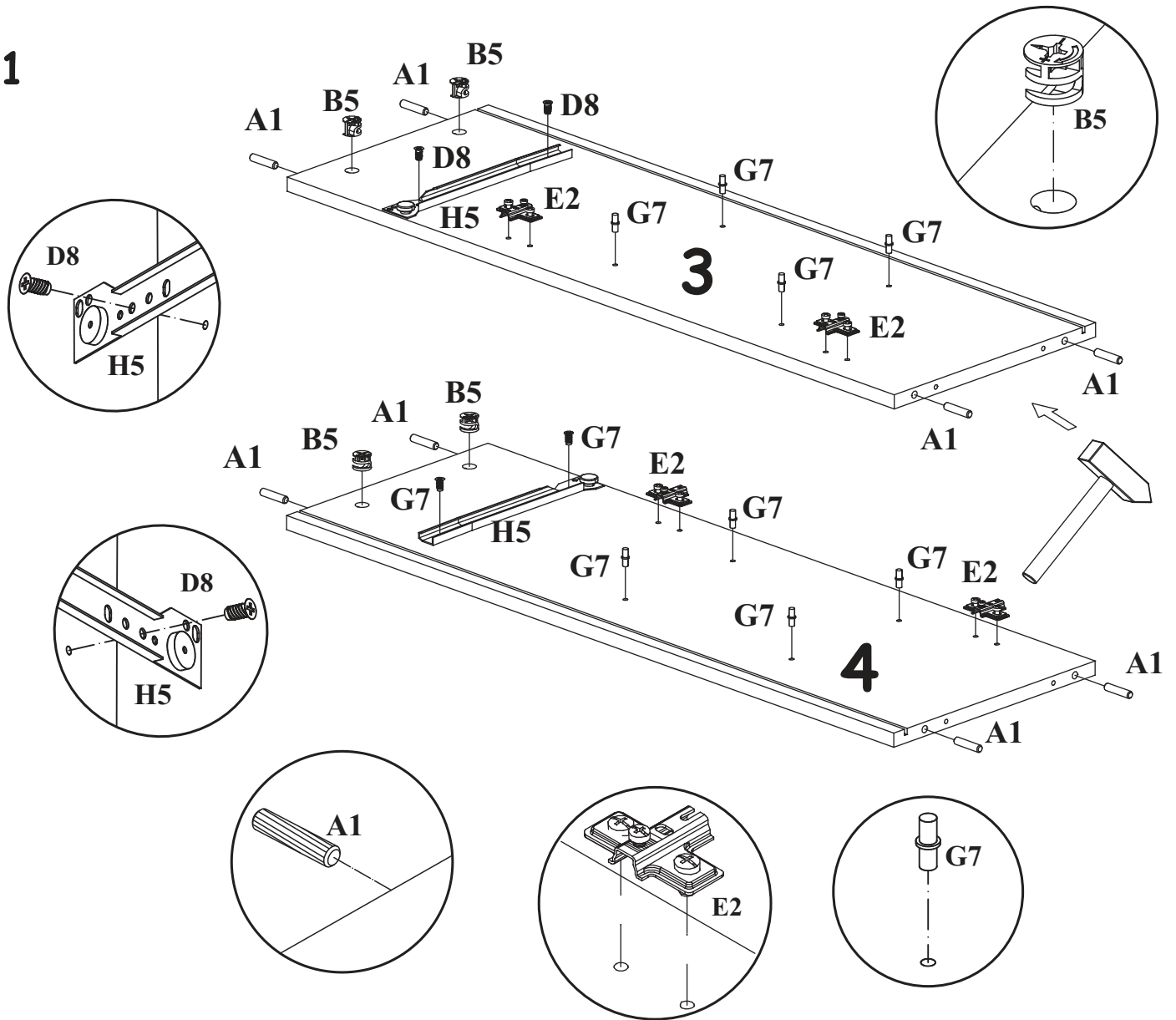

2

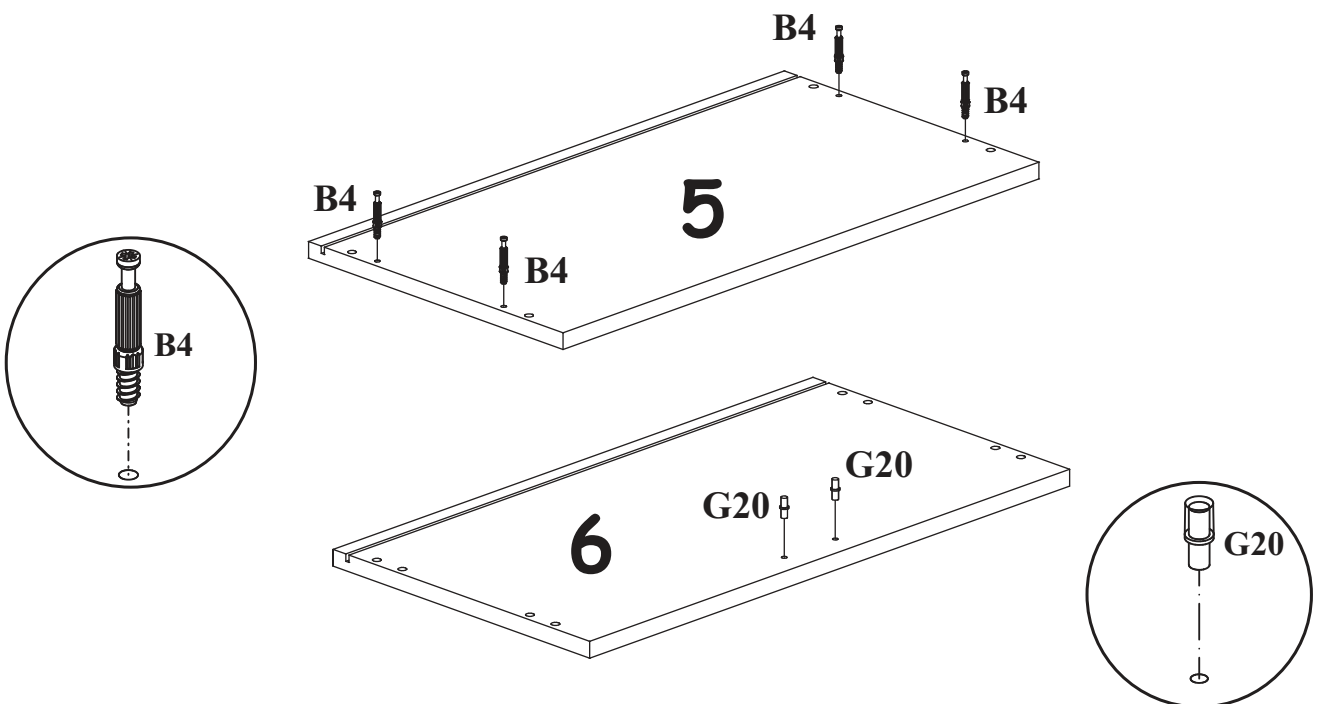

3

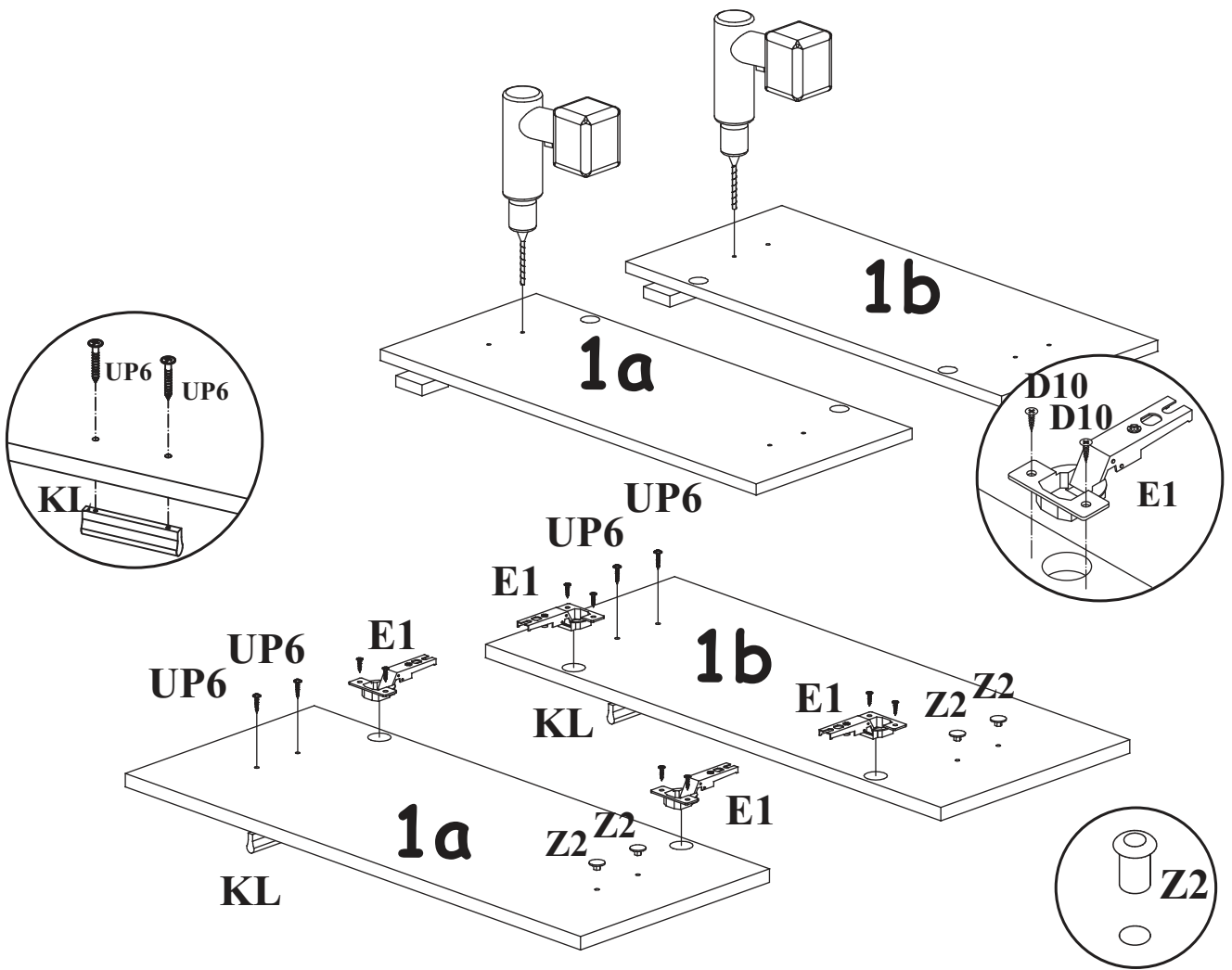

4

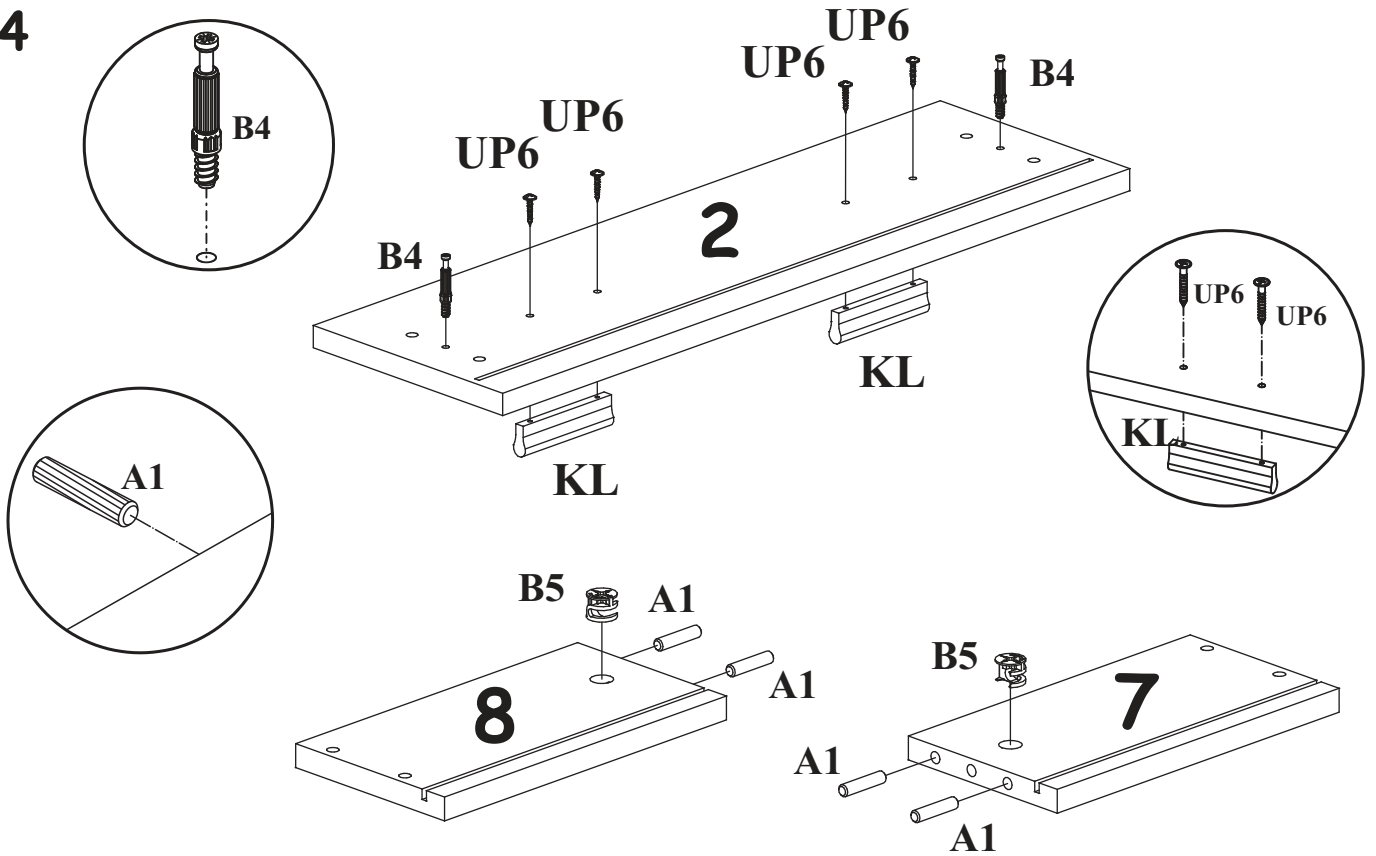

5

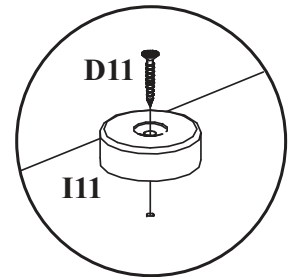
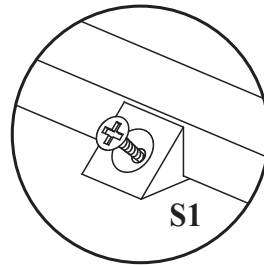
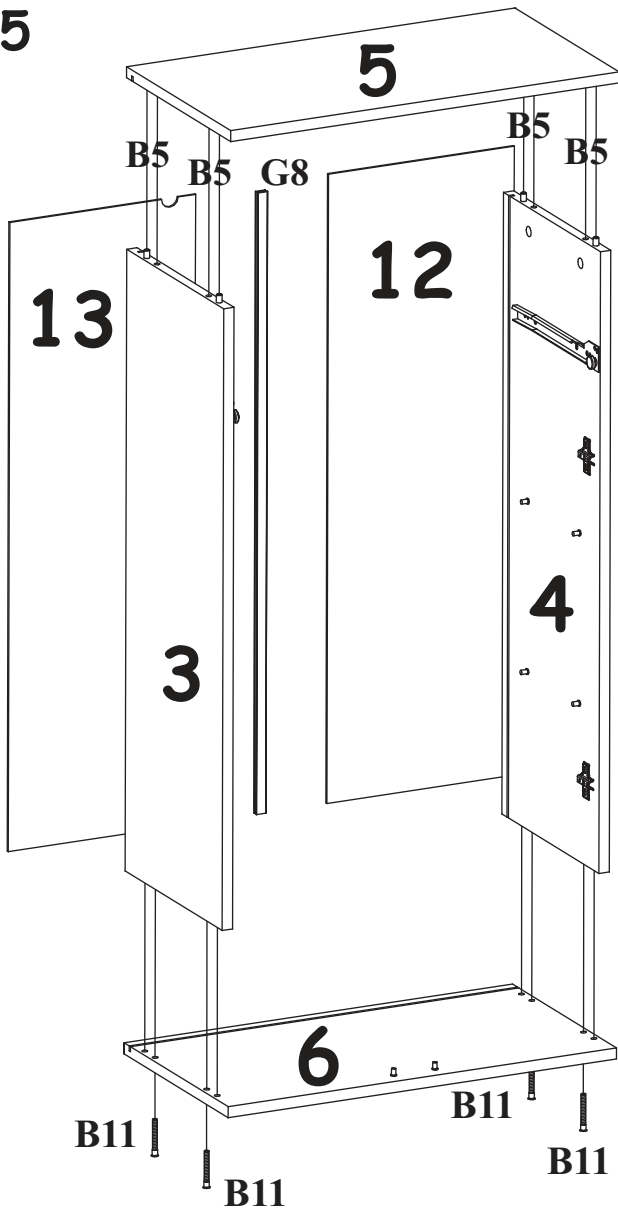

$X=Y$ 90°

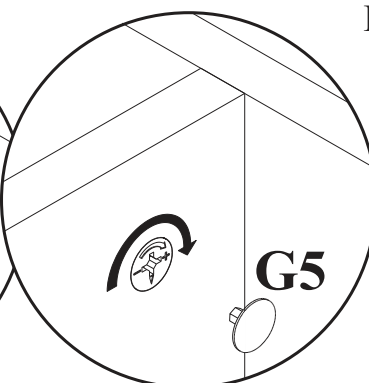
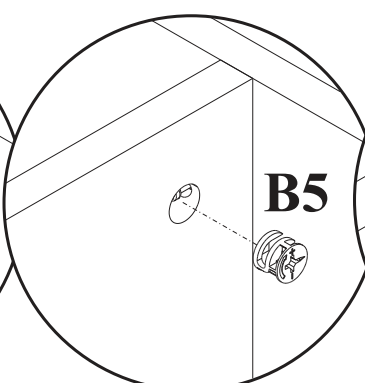
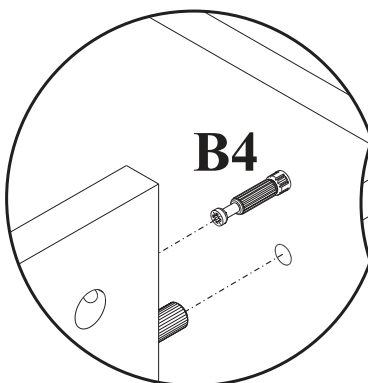
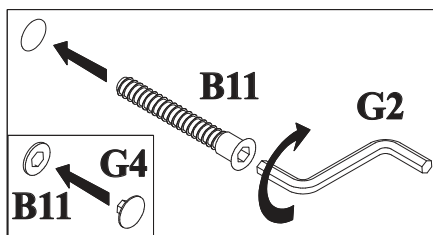
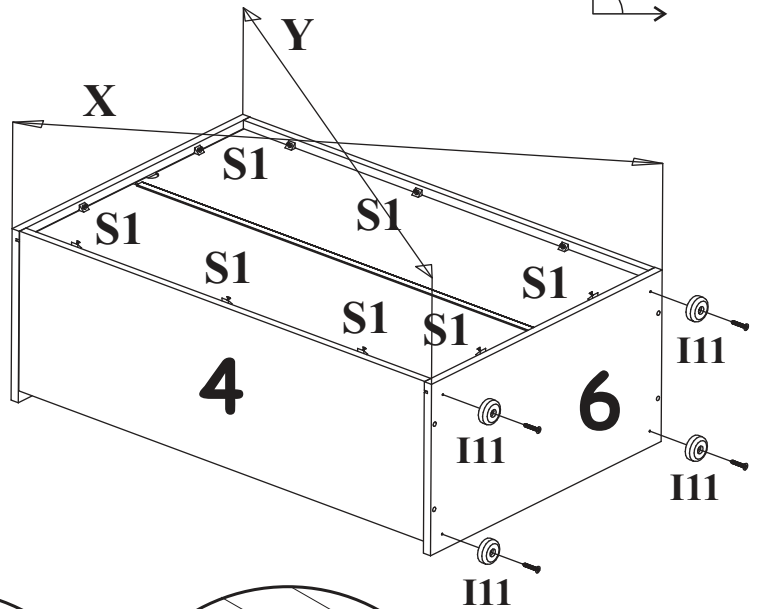

6

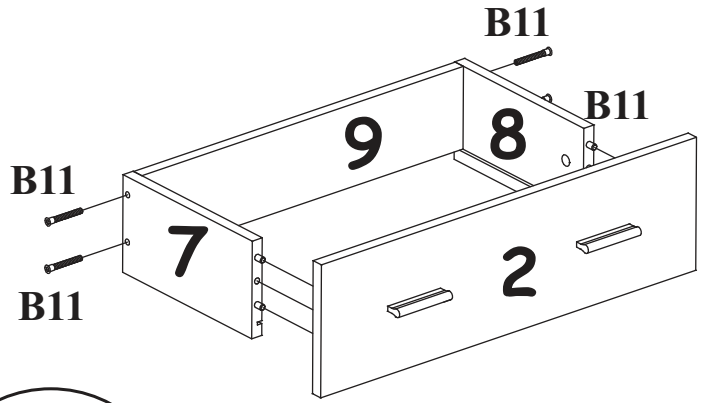
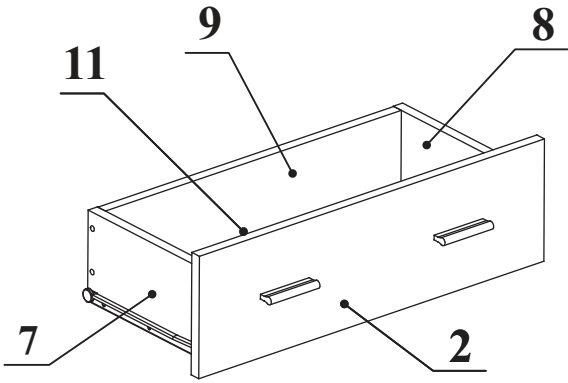

180°

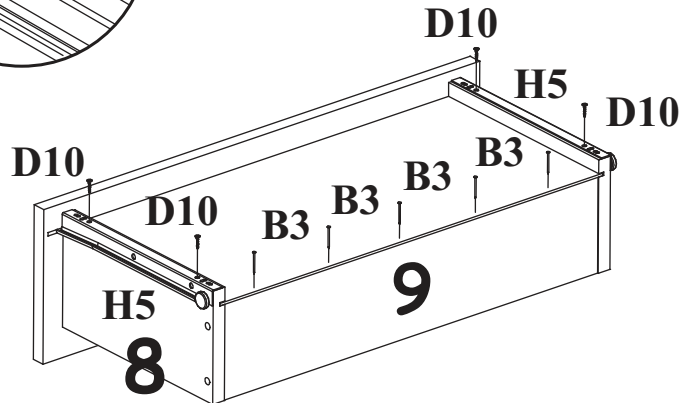
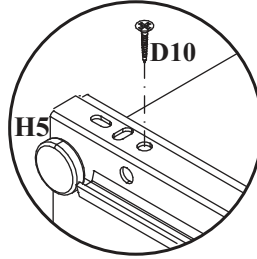
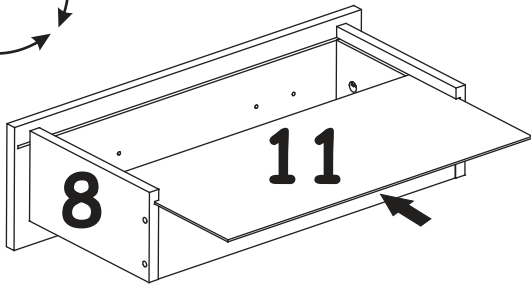

7

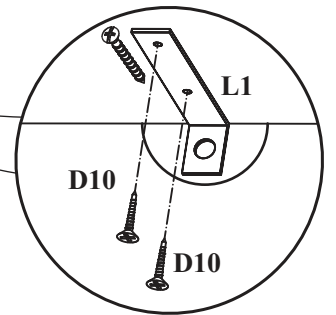
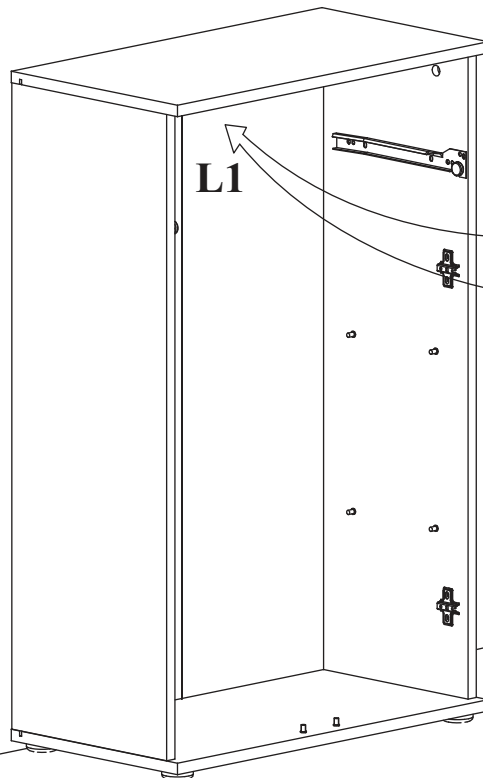
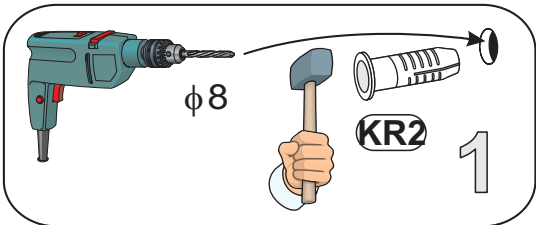

8

