

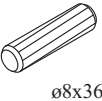







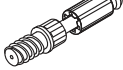
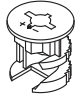

80 min.

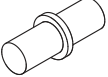
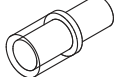
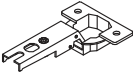
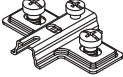
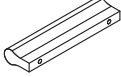
| | | | | | | | | | | | |
|----------|--|-----------|--|-----------|--|-----------|---|-----------|--|-----------|--|
| A1 X8 |  ø8x36 | B11 X4 |  Ø7x50 | G4 X4 |  | B4 X4 |  | B5 X4 |  ø15x12 | G5 X4 |  |
| G7 X4 |  | G20 X2 |  | E1 X4 |  H=0 | E2 X4 |  H=0 | KL X2 |  | UP6 X4 |  UPØ4x30 |
| Z2 X4 |  ø5 | S1 X6 |  | I11 X4 |  | D10 X8 |  USØ3,5x13 | D11 X4 |  USØ3,5x25 | G2 X1 |  |

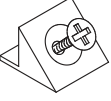
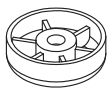

1

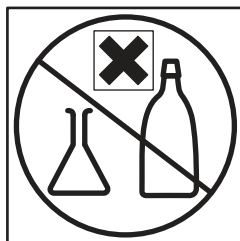
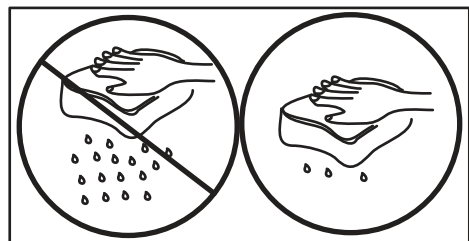
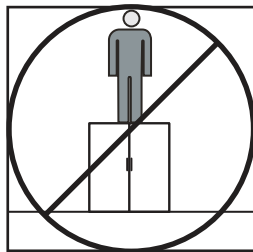
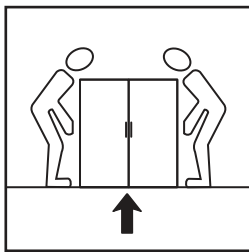
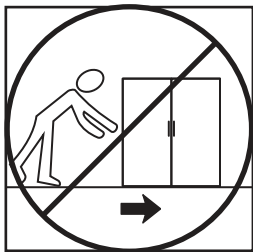
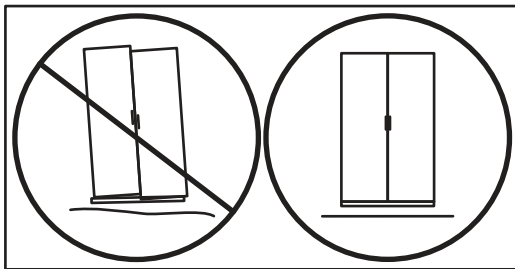
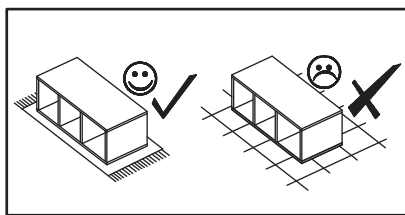
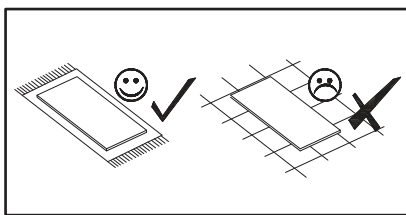
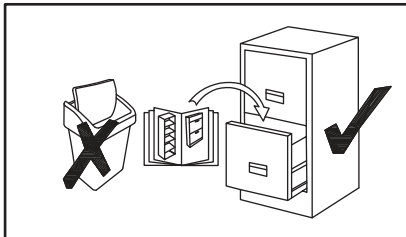
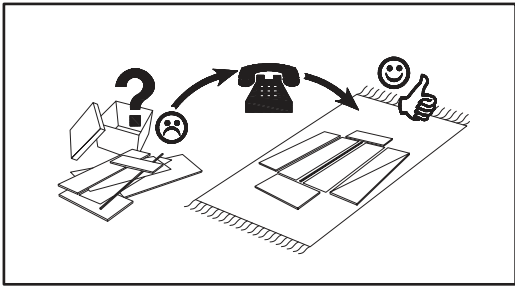
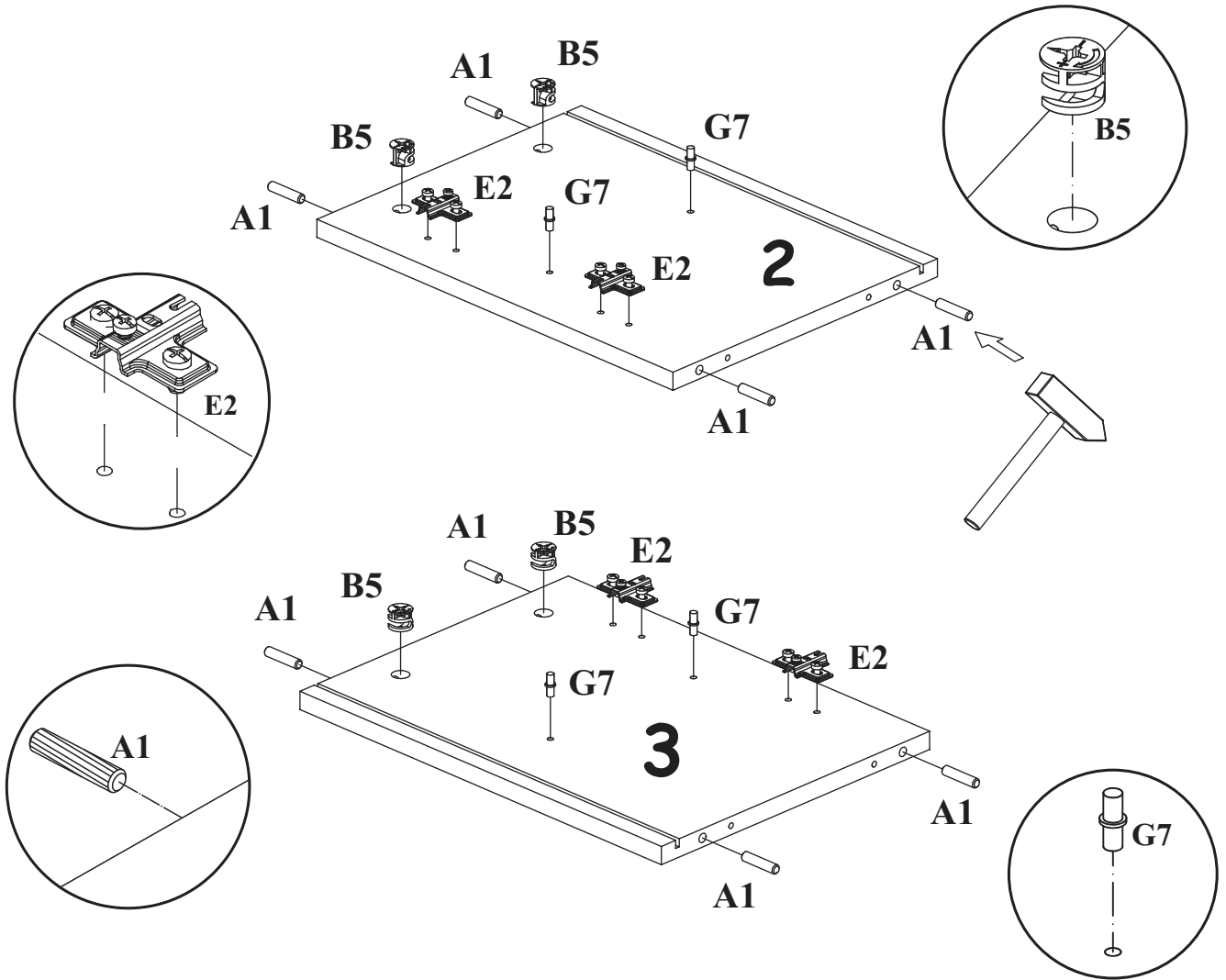

2

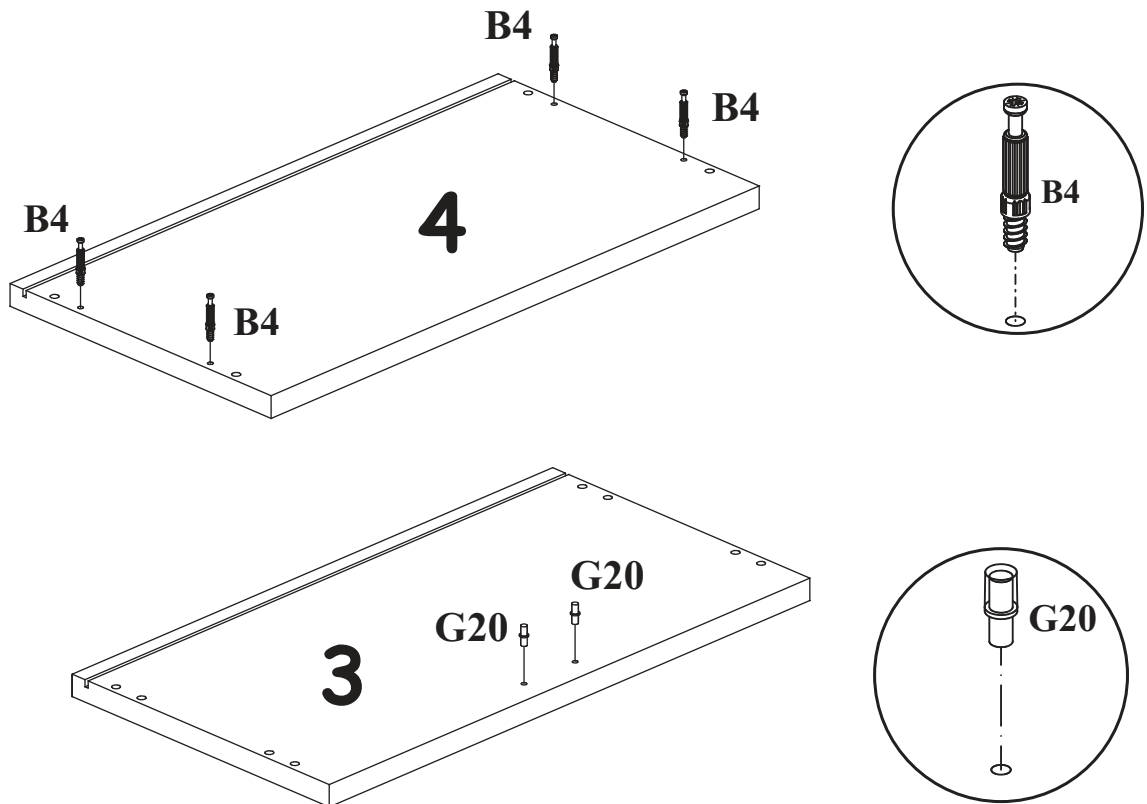

3

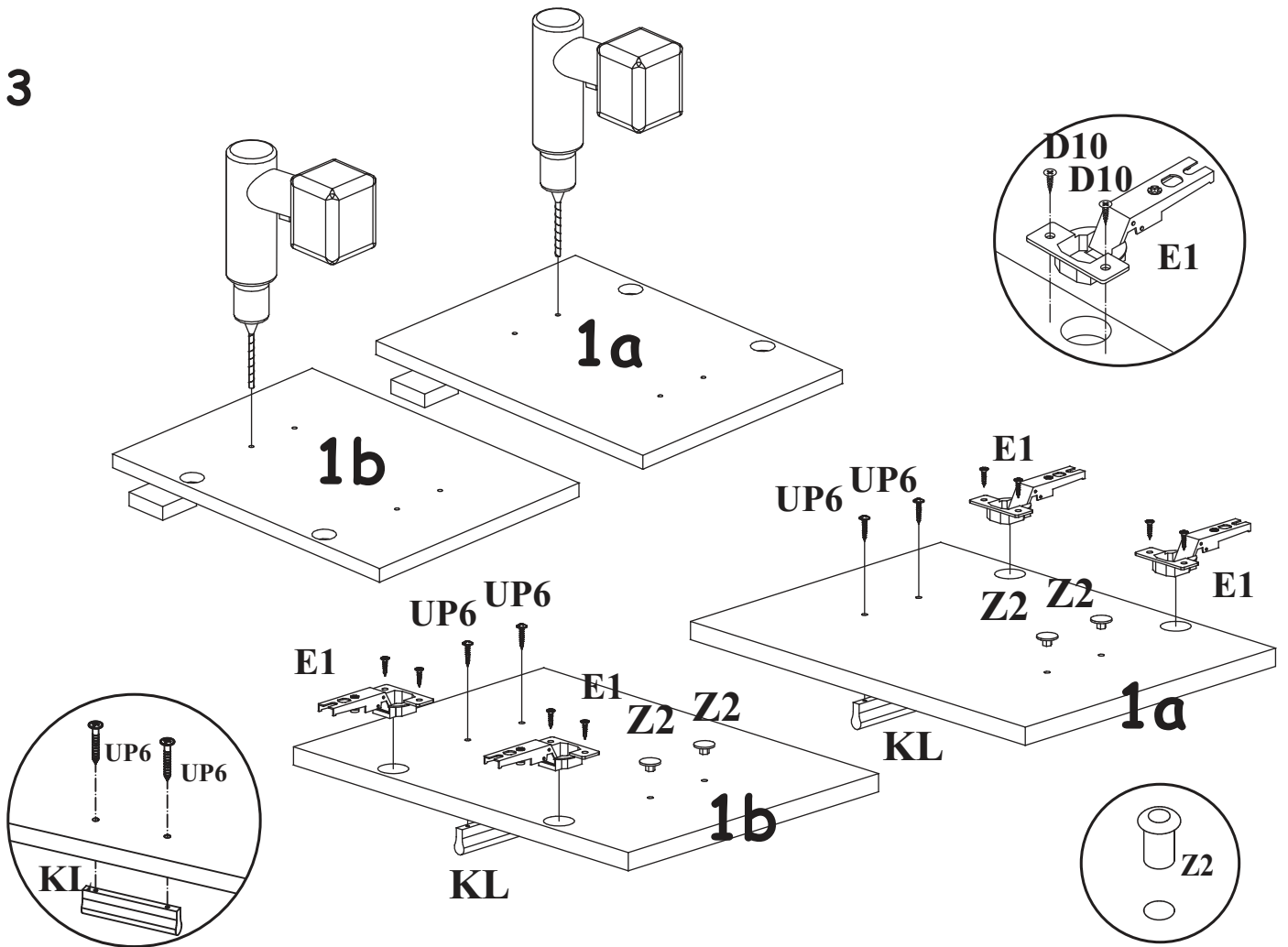

4

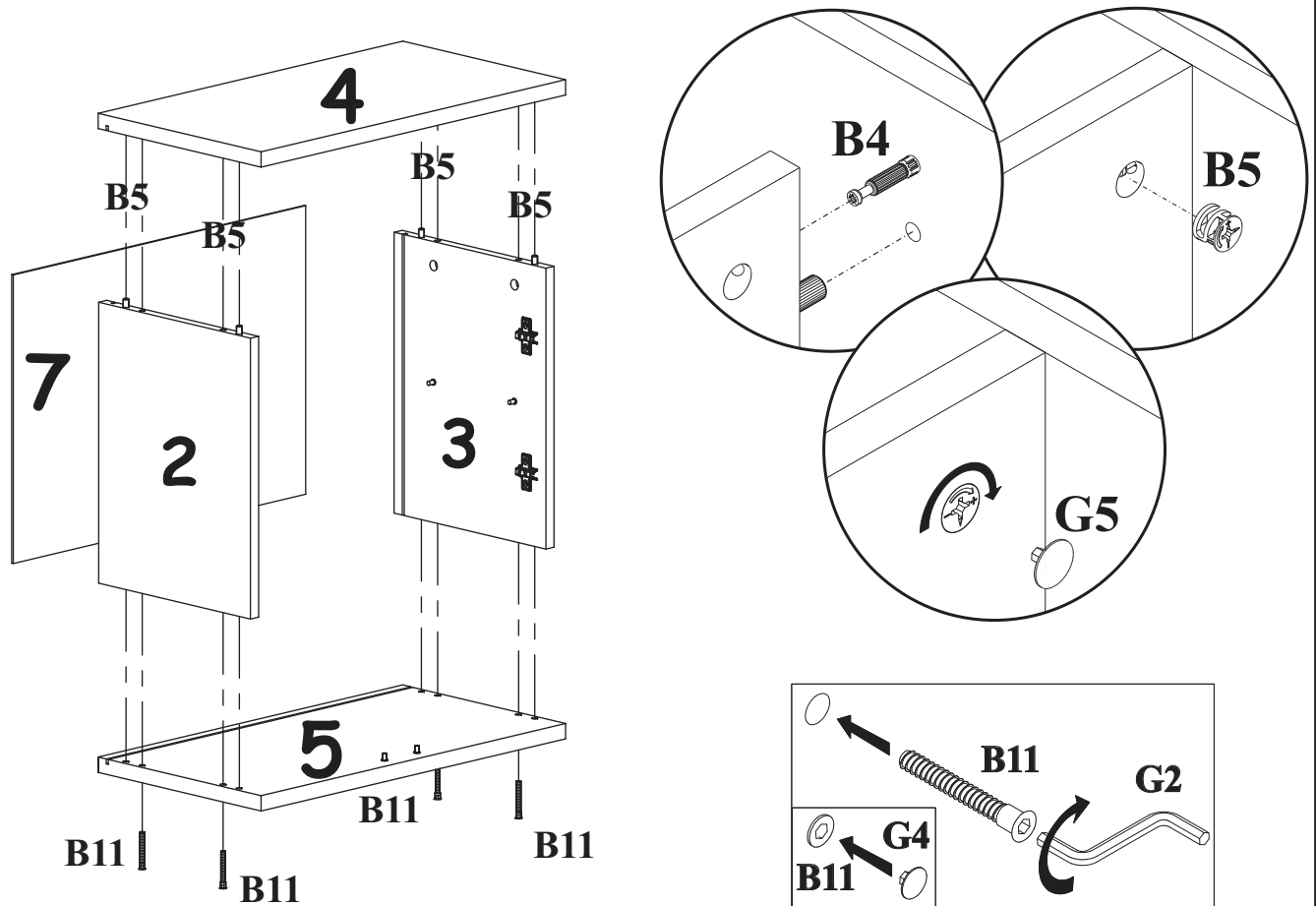

5

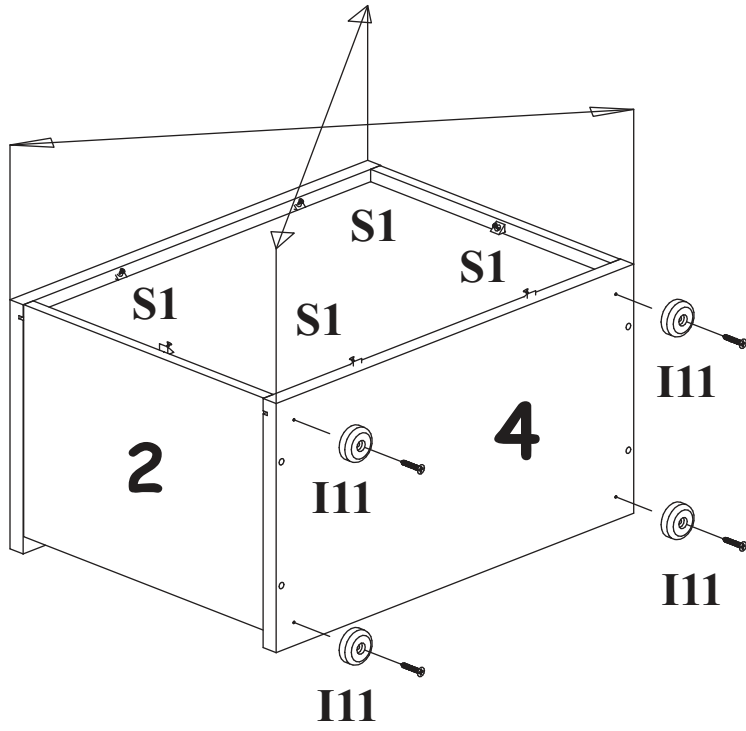

$X=Y$ 90°

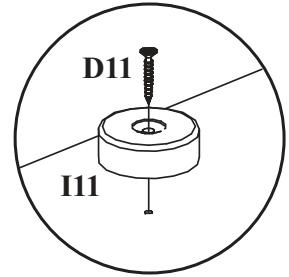
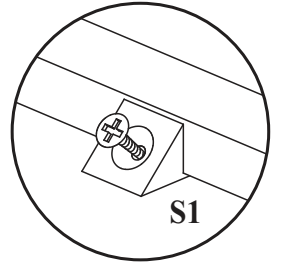

6

